

Silizium-PIN-Fotodiode mit sehr kurzer Schaltzeit

Silicon PIN Photodiode with Very Short Switching Time

SFH 2400

SFH 2400 FA



SFH 2400

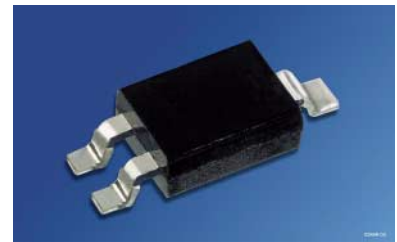

SFH 2400 FA

Wesentliche Merkmale

- Speziell geeignet für Anwendungen im Bereich von 400 nm bis 1100 nm (SFH 2400) und bei 880 nm (SFH 2400 FA)
- Kurze Schaltzeit (typ. 5 ns)
- SMT-Bauform, geeignet für Vapor Phase-Löten und IR-Reflow-Löten (JEDEC level 4)
- Nur gegurtet lieferbar

Features

- Especially suitable for applications from 400 nm to 1100 nm (SFH 2400) and of 880 nm (SFH 2400 FA)
- Short switching time (typ. 5 ns)
- SMT package, suitable for vapor phase and IR reflow soldering (JEDEC level 4)
- Available only on tape and reel

Anwendungen

- Industrieelektronik
- „Messen/Steuern/Regeln“
- Schnelle Lichtschranken für Gleich- und Wechsellichtbetrieb

Applications

- Industrial electronics
- For control and drive circuits
- Photointerrupters

| Typ Type | Bestellnummer Ordering Code | Gehäuse Package |
|-------------|--------------------------------|---|
| SFH 2400 | Q62702-P1794 | Klares Epoxy-Gießharz, Kathodenkennzeichnung: breiter Anschluß Transparent epoxy resin, cathode marking: broad lead |
| SFH 2400 FA | Q62702-P5035 | Schwarzes Epoxy-Gießharz, Kathodenkennzeichnung: breiter Anschluß Black epoxy resin, cathode marking: broad lead |

Grenzwerte
Maximum Ratings

| Bezeichnung Parameter | Symbol Symbol | Wert Value | Einheit Unit |
|--|-------------------|----------------|-----------------|
| Betriebs- und Lagertemperatur Operating and storage temperature range | $T_{op}; T_{stg}$ | - 40 ... + 100 | °C |
| Sperrspannung Reverse voltage | V_R | 20 | V |
| Sperrspannung $t < 2$ min Reverse voltage $t < 2$ min | V_R | 50 | V |
| Verlustleistung Total power dissipation | P_{tot} | 120 | mW |
| Wärmewiderstand für Montage auf PC-Board Thermal resistance for mounting on pcb | R_{thJA} | 450 | K/W |

Kennwerte ($T_A = 25$ °C)
Characteristics

| Bezeichnung Parameter | Symbol Symbol | Wert Value | | Einheit Unit |
|---|------------------------------|---------------|--------------|-----------------|
| | | SFH 2400 | SFH 2400 FA | |
| Fotostrom Photocurrent $V_R = 5$ V, Normlicht/standard light A, $T = 2856$ K, $E_V = 1000$ lx $V_R = 5$ V, $\lambda = 870$ nm, $E_e = 1$ mW/cm ² | I_P | 10 (> 6) | – | µA |
| | I_P | 6.5 | 6.2 (≥ 3.6) | µA |
| Wellenlänge der max. Fotoempfindlichkeit Wavelength of max. sensitivity | $\lambda_{S\ max}$ | 850 | 900 | nm |
| Spektraler Bereich der Fotoempfindlichkeit $S = 10\%$ von S_{max} Spectral range of sensitivity $S = 10\%$ of S_{max} | λ | 400 ... 1100 | 750 ... 1100 | nm |
| Bestrahlungsempfindliche Fläche Dimensions of radiant sensitive area | $L \times B$ $L \times W$ | 1 × 1 | 1 × 1 | mm × mm |
| Chipgröße Chip size | $L \times B$ $L \times W$ | 1.4 × 1.4 | 1.4 × 1.4 | mm × mm |
| Halbwinkel Half angle | φ | ± 60 | ± 60 | Grad deg. |

Kennwerte ($T_A = 25\text{ °C}$)

Characteristics (cont'd)

| Bezeichnung Parameter | Symbol Symbol | Wert Value | | Einheit Unit |
|---|--------------------------|-----------------------|-----------------------|--|
| | | SFH 2400 | SFH 2400 FA | |
| Dunkelstrom, $V_R = 20\text{ V}$ Dark current | I_R | 1 (< 5) | 1 (< 5) | nA |
| Leerlaufspannung Open-circuit voltage $E_V = 1000\text{ lx}$, Normlicht/standard light A, $T = 2856\text{ K}$ $E_e = 1\text{ mW/cm}^2$, $\lambda = 870\text{ nm}$ | V_O V_O | 320 – | – 320 | mV mV |
| Kurzschlußstrom Short-circuit current $E_V = 1000\text{ lx}$, Normlicht/standard light A, $T = 2856\text{ K}$ $E_e = 1\text{ mW/cm}^2$, $\lambda = 870\text{ nm}$ | I_{SC} I_{SC} | 10 – | – 6.0 | μA μA |
| Anstiegs- und Abfallzeit des Fotostromes Rise and fall time of the photocurrent $R_L = 50\ \Omega$; $V_R = 20\text{ V}$; $\lambda = 850\text{ nm}$; $I_p = 800\ \mu\text{A}$ | t_r, t_f | 5 | 5 | ns |
| Durchlaßspannung, $I_F = 80\text{ mA}$, $E = 0$ Forward voltage | V_F | 1.3 | 1.3 | V |
| Kapazität, $V_R = 0\text{ V}$, $f = 1\text{ MHz}$, $E = 0$ Capacitance | C_0 | 11 | 11 | pF |
| Temperaturkoeffizient von V_O Temperature coefficient of V_O | TC_V | – 2.6 | – 2.6 | mV/K |
| Temperaturkoeffizient von I_{SC} Temperature coefficient of I_{SC} Normlicht/standard light A $\lambda = 870\text{ nm}$ | TC_I | 0.18 – | – 0.2 | %/K |
| Rauschäquivalente Strahlungsleistung Noise equivalent power $V_R = 20\text{ V}$, $\lambda = 870\text{ nm}$ | NEP | 2.9×10^{-14} | 2.9×10^{-14} | $\frac{\text{W}}{\sqrt{\text{Hz}}}$ |
| Nachweisgrenze, $V_R = 20\text{ V}$, $\lambda = 870\text{ nm}$ Detection limit | D^* | 3.5×10^{12} | 3.5×10^{12} | $\frac{\text{cm} \times \sqrt{\text{Hz}}}{\text{W}}$ |

Relative Spectral Sensitivity
SFH 2400, $S_{rel} = f(\lambda)$

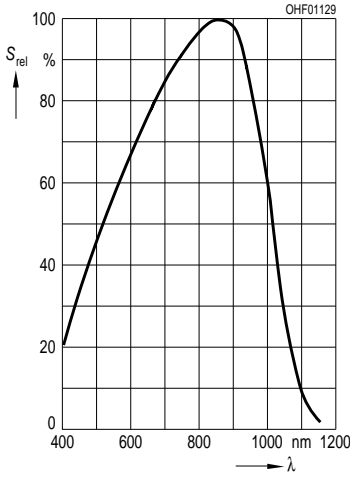

Relative Spectr. Sensitivity
SFH 2400 FA, $S_{rel} = f(\lambda)$

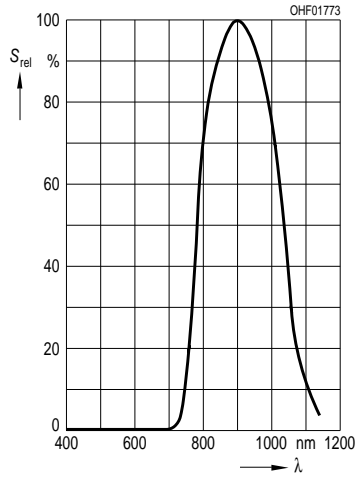

Total Power Dissipation
 $P_{tot} = f(T_A)$

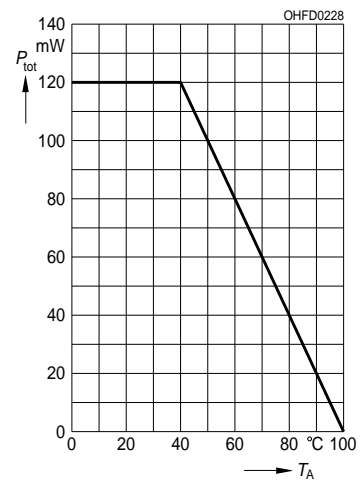

Photocurrent $I_P = f(E_e)$, $V_R = 5 V$
Open-Circuit Voltage $V_O = f(E_e)$
SFH 2400 FA

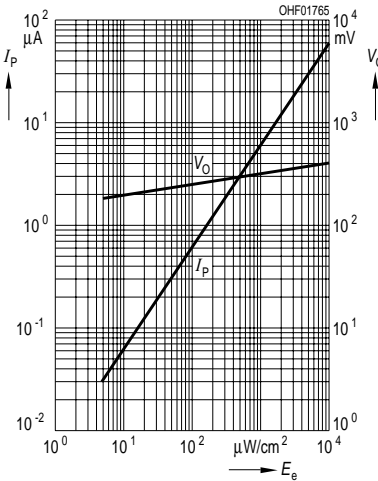

Photocurrent $I_P = f(E_v)$, $V_R = 5 V$
Open-Circuit Voltage $V_O = f(E_v)$
SFH 2400

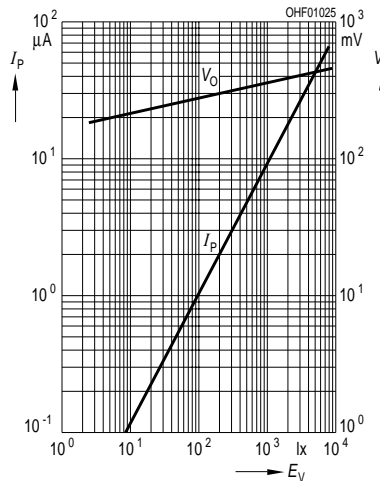

Dark Current
 $I_R = f(V_R), E = 0$

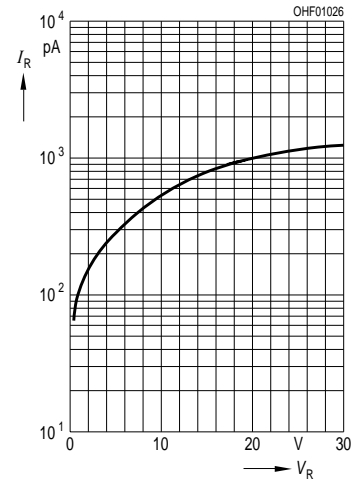

Directional Characteristics
 $S_{rel} = f(\phi)$

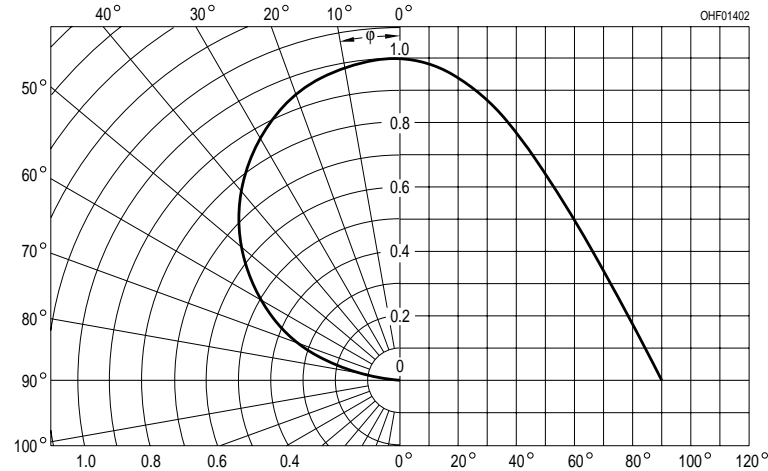

Capacitance
 $C = f(V_R), f = 1 MHz, E = 0$

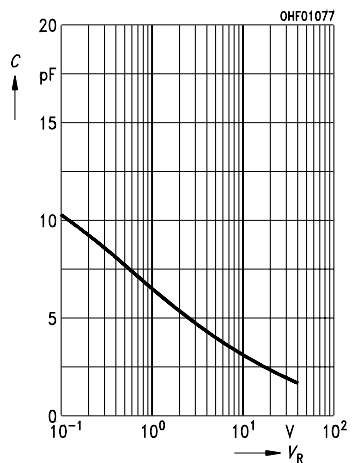

Maßzeichnung Package Outlines

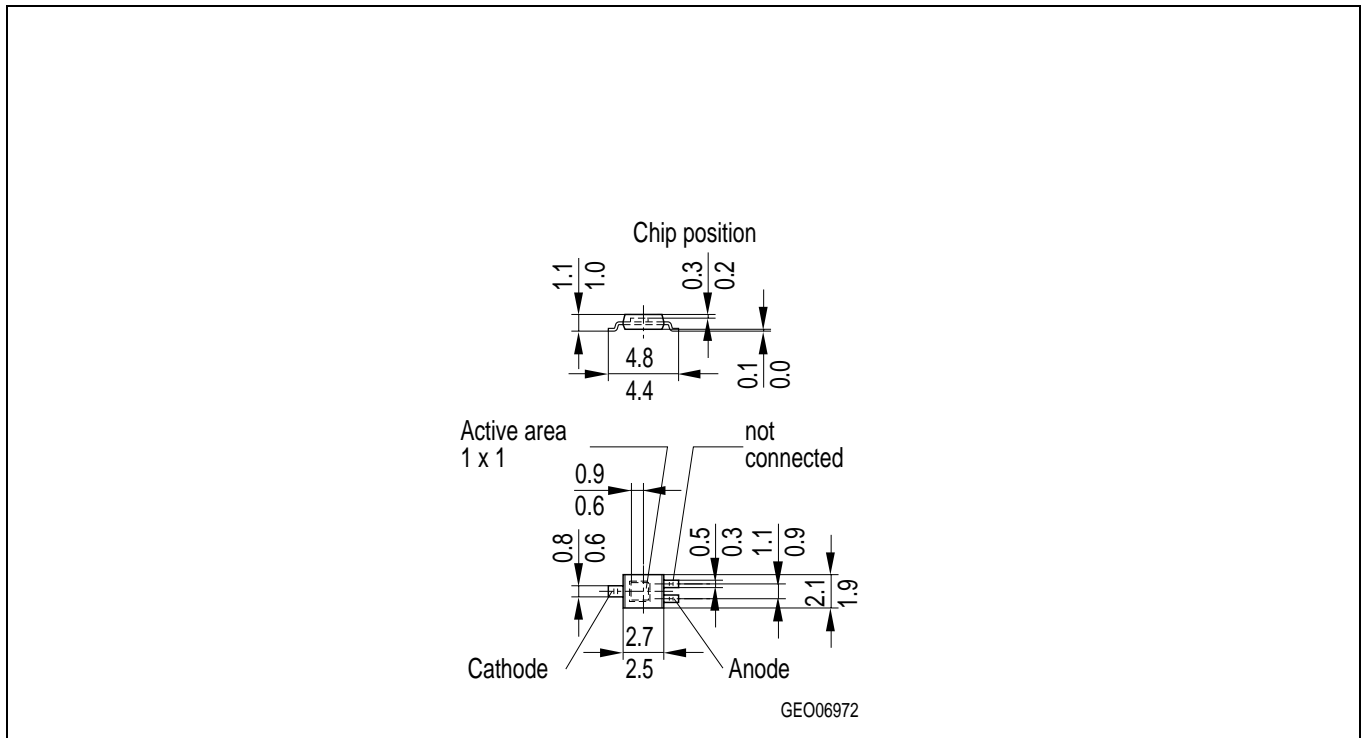

Maße werden wie folgt angegeben: mm (inch) / Dimensions are specified as follows: mm (inch).

Published by OSRAM Opto Semiconductors GmbH & Co. OHG
Wernerwerkstrasse 2, D-93049 Regensburg

© All Rights Reserved.

Attention please!

The information describes the type of component and shall not be considered as assured characteristics. Terms of delivery and rights to change design reserved. Due to technical requirements components may contain dangerous substances. For information on the types in question please contact our Sales Organization.

Packing

Please use the recycling operators known to you. We can also help you – get in touch with your nearest sales office. By agreement we will take packing material back, if it is sorted. You must bear the costs of transport. For packing material that is returned to us unsorted or which we are not obliged to accept, we shall have to invoice you for any costs incurred.

Components used in life-support devices or systems must be expressly authorized for such purpose! Critical components¹, may only be used in life-support devices or systems² with the express written approval of OSRAM OS.

¹ A critical component is a component used in a life-support device or system whose failure can reasonably be expected to cause the failure of that life-support device or system, or to affect its safety or effectiveness of that device or system.

² Life support devices or systems are intended (a) to be implanted in the human body, or (b) to support and/or maintain and sustain human life. If they fail, it is reasonable to assume that the health of the user may be endangered.